

KENWOOD

AUDIO VIDEO SURROUND RECEIVER

KR-300HT

INSTRUCTION MANUAL

KENWOOD CORPORATION

Model availability and features (functions) may differ depending on country and sales area.

Before applying power

KR-300HT (En/K)

Before applying power

Caution: Read this section carefully to ensure safe operation.

Units are designed for operation as follows.

U.S.A. and Canada AC120 V only
Australia AC 240 V only

Europe and U.K. AC 230 V only
China and Russia AC 220 V only
*Other countries AC 110-120/220-240 V switchable

*AC voltage selection

The AC voltage selector switch on the rear panel is set to the voltage that prevails in the area to which the unit is shipped. Before connecting the power cord to your AC outlet, make sure that the setting position of this switch matches your line voltage. If not, it must be set to your voltage in accordance with the following direction.



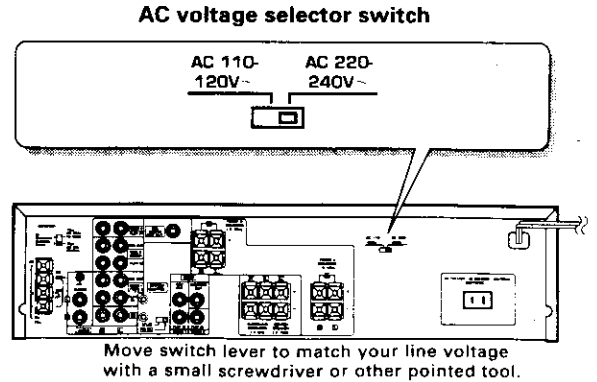

Note:
Our warranty does not cover damage caused by excessive line voltage due to improper setting of the AC voltage selector switch.



Safety precautions

Caution: Read this section carefully to ensure safe operation.



WARNING: TO PREVENT FIRE OR ELECTRIC SHOCK, DO NOT EXPOSE THIS APPLIANCE TO RAIN OR MOISTURE.

 <div data-bbox="349 955 560 1029" style="border: 1px solid black; padding: 2px; text-align: center;"> CAUTION <small>RISK OF ELECTRIC SHOCK DO NOT OPEN</small> </div> 	<p>CAUTION: TO REDUCE THE RISK OF ELECTRIC SHOCK, DO NOT REMOVE COVER (OR BACK). NO USER-SERVICEABLE PARTS INSIDE, REFER SERVICING TO QUALIFIED SERVICE PERSONNEL.</p>
	<p>THE LIGHTNING FLASH WITH ARROWHEAD SYMBOL, WITHIN AN EQUILATERAL TRIANGLE, IS INTENDED TO ALERT THE USER TO THE PRESENCE OF UNINSULATED "DANGEROUS VOLTAGE" WITHIN THE PRODUCT'S ENCLOSURE THAT MAY BE OF SUFFICIENT MAGNITUDE TO CONSTITUTE A RISK OF ELECTRIC SHOCK TO PERSONS.</p>
	<p>THE EXCLAMATION POINT WITHIN AN EQUILATERAL TRIANGLE IS INTENDED TO ALERT THE USER TO THE PRESENCE OF IMPORTANT OPERATING AND MAINTENANCE (SERVICING) INSTRUCTIONS IN THE LITERATURE ACCOMPANYING THE APPLIANCE.</p>

Unpacking

Unpack the unit carefully and make sure that all accessories are put aside so they will not be lost. Examine the unit for any possibility of shipping damage. If your unit is damaged or fails to operate, notify your dealer immediately. If your unit was shipped to you directly, notify the shipping company without delay. Only the consignee (the person or company receiving the unit) can file a claim against the carrier for shipping damage. We recommend that you retain the original carton and packing materials for use should you transport or ship the unit in the future.

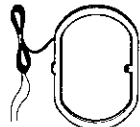
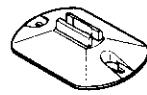
Accessories

<p>FM indoor antenna (1)</p> 	<p>AM loop antenna (1)</p> 	<p>Loop antenna stand (1)</p> 
<p>Remote control unit (1)</p> 	<p>Batteries (R6/AA) (2)</p> 	

Special features

DOLBY PRO LOGIC & DOLBY 3 STEREO

The surround system reproduces video software programs carrying the  mark with similar acoustic effects to movie theaters.

The DOLBY PRO LOGIC mode controls the audio signals of the Front Left/Right, Center and Rear surround channels using the built-in directivity enhancer circuit to reproduce the feeling of sound motions very realistically.

The DOLBY 3 STEREO mode can reproduce the motions of sound even when only the front and center speakers are used, by providing proper acoustic position using the directivity enhancer circuit.

DSP LOGIC & DSP presence

The DSP LOGIC mode adds presence sound components obtained from the DSP (Digital Signal Processor) to the signals output from the DOLBY PRO LOGIC (Left, Center, Right and Surround channels), allowing movie software programs to be played with a similar feeling of presence to movie theaters in a listening room in home.



The DSP presence mode adds presence sound components obtained from the DSP to the original source signals, allowing music source entertainment with the feeling of presence in an arena, stadium or jazz club in a listening room at home.

SRS 3D Stereo

The SRS (Sound Retrieval System) is an innovative system simulating a 3-dimensional sound space, which features clearly improved feelings of depth, sound field extension and acoustic image positioning as well as a widened listening area.

Contents

Caution : Read the pages marked  carefully to ensure safe operation.

Before applying power	2
 Before applying power	2
 Safety precautions	2
Special features	3
System connection	4
Connections of Audio and Video components	4
About the system control connections	5
Connections of speakers	6
Connections of antenna	7
FM DE-EMPHASIS/CHANNEL SPACE switch	8
Controls and indicators	9
Operation of remote control unit	10
Playing music	12
Sound adjustment functions	13
Recording	16
Broadcast Reception	17
Receiving broadcast stations	17
Receiving radio stations by specifying its frequency	18
Storing radio stations in memory (Station preset)	19
Receiving a preset station	19
Receiving all preset stations in order (P.CALL)	19
Operation of video components	20
Playback of videotape	20
Recording of video source (VIDEO2 /AV AUX → VIDEO1)	20
Presence play	21
Adjustments for surround play	22
Surround play	24
Adjusting the surround effects (DSP presence and DSP LOGIC modes only)	25
SRS 3D Stereo (Sound Retrieval System)	26
In case of difficulty	28
 Specifications	30

Connections of Audio and Video components

Make connection as shown below.

When connecting the related system components, refer also to the instruction manuals of the related components.

⚠ Do not plug in the power lead until all connections are completed.

Malfunction of microcomputer

If operation is not possible or erroneous display appears even though all connections have been made properly, reset the microcomputer referring to "In case of difficulty".

-29-

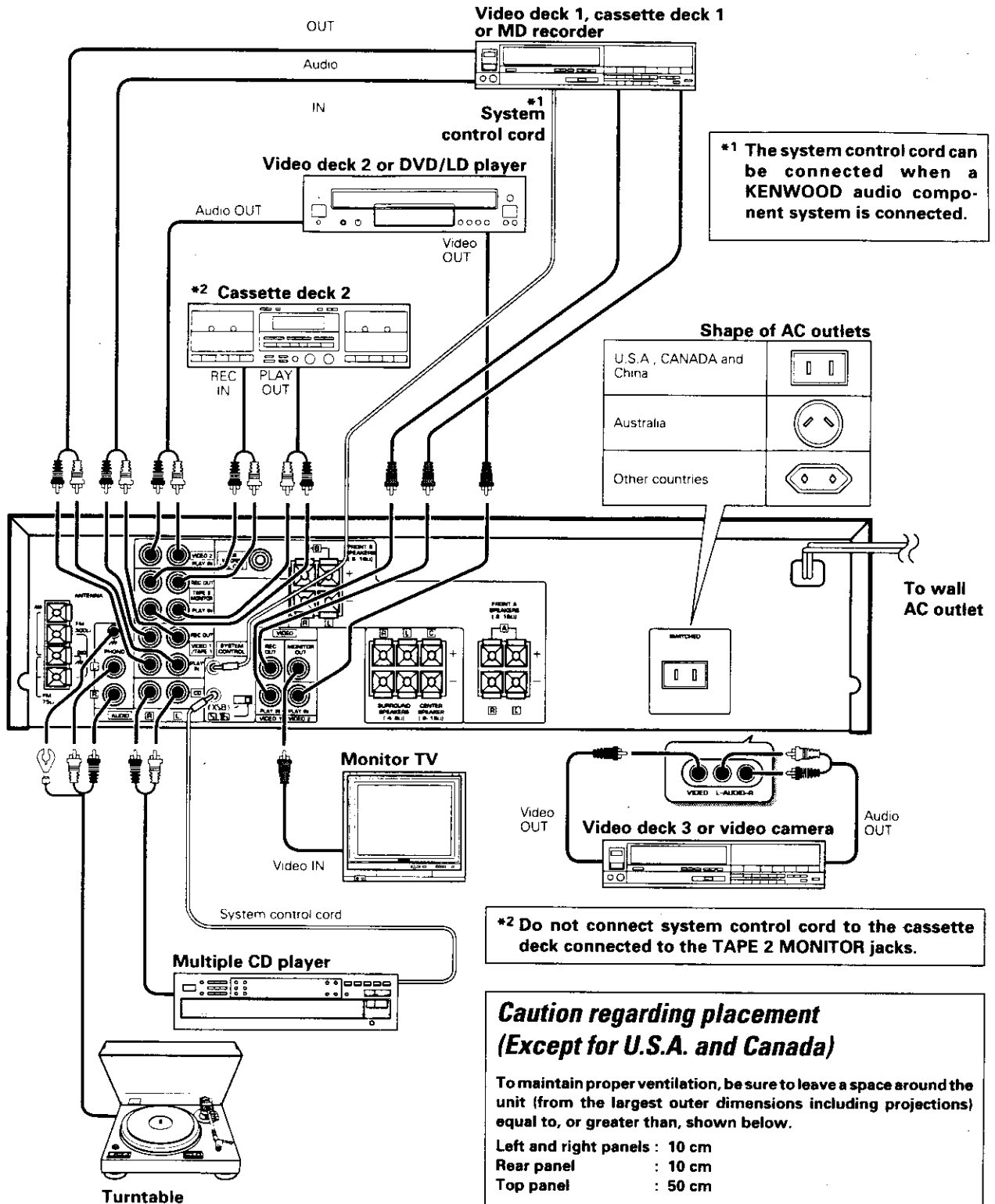

About the system control connections

5

Connecting system control cords after connecting a KENWOOD audio component system lets you take advantage of convenient system control operations.

There are two KENWOOD system control modes. Make connections according to the groups of terminal symbols shown below.

[XS8] Mode: lets you combine [XR], [XS], and [XS8] terminals

[SL16] Mode: for [SL16] terminals only

This unit is compatible with both [XS8] and [SL16] modes. It comes from the factory set to the [SL16] mode. To switch to the [XS8] mode, follow the instructions in "SWITCHING BETWEEN [XS8] AND [SL16]" below.

EXAMPLE: [XS8] mode connections

The underlined portion represents the setting of the system control mode.

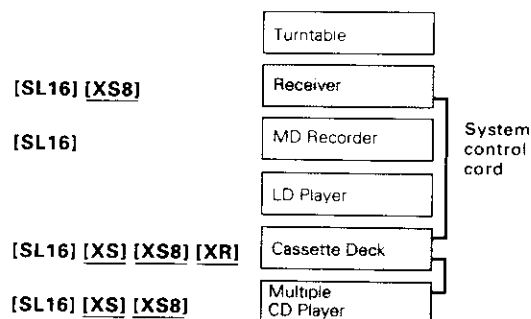

EXAMPLE: [SL16] mode connections

The underlined portion represents the setting of the system control mode.

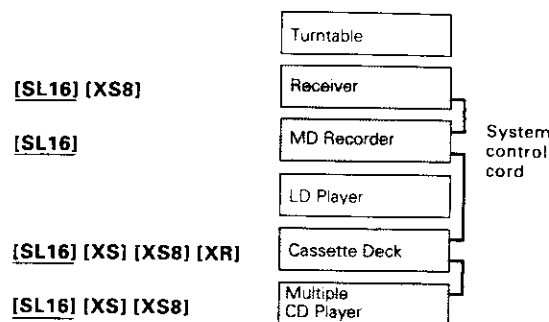

- Some CD players and cassette decks are not compatible with the [SL16] system control mode. Be sure to use the [XS8] system control mode when making system connections with equipment that is not [SL16] compatible.
- Some MD players are not system control compatible. You cannot make system control connections to this kind of equipment.



- [SL16] equipment cannot be combined with [XR], [XS], and [XS8] equipment for system operations. If your equipment consists of this kind of combination, please do not connect any system control cords. Even without system control cords, normal operations can be carried out without affecting performance.
- Do not connect system control cords to any components other than those specified by KENWOOD. It may cause a malfunction and damage your equipment.
- Be sure the system control plugs are inserted all the way in to the system control terminals.

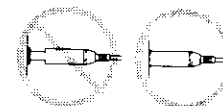

ABOUT THE SYSTEM CONTROL OPERATIONS

Remote Control (possible when the system control mode matches)

Lets you operate source components with the system remote supplied with this unit.

Automatic Operation (Except [XR] equipment)

When you start playback from a source component, the input selector on this unit switches to that component automatically. (Except TAPE 2)

Synchronized Recording (Except [XR] equipment)

Lets you synchronize recording with the start of playback when recording from CD or MD.

SWITCHING BETWEEN [XS8] AND [SL16]

The system control mode can be switched over easily with the following operation.

- Unplug the AC power cord from the wall outlet.
- Set the SYSTEM CONTROL switch on the rear panel to the desired position.

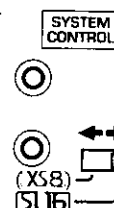

- This operation does not affect the items stored in memory.



- Connect all cords firmly. If connections are loose, there could be loss of sound or noise produced.
- When plugging and unplugging connection cords, be sure to first remove the power cord from the AC outlet. Plugging / unplugging connection cords without removal of the power cord can cause malfunctions or damage to the unit.
- Do not connect up a power source which is larger than that indicated on the socket at the rear of the unit.
- If the system control cords or audio cords are not connected properly, the remote control or automatic operation between system components will not work properly.

Connection of speakers

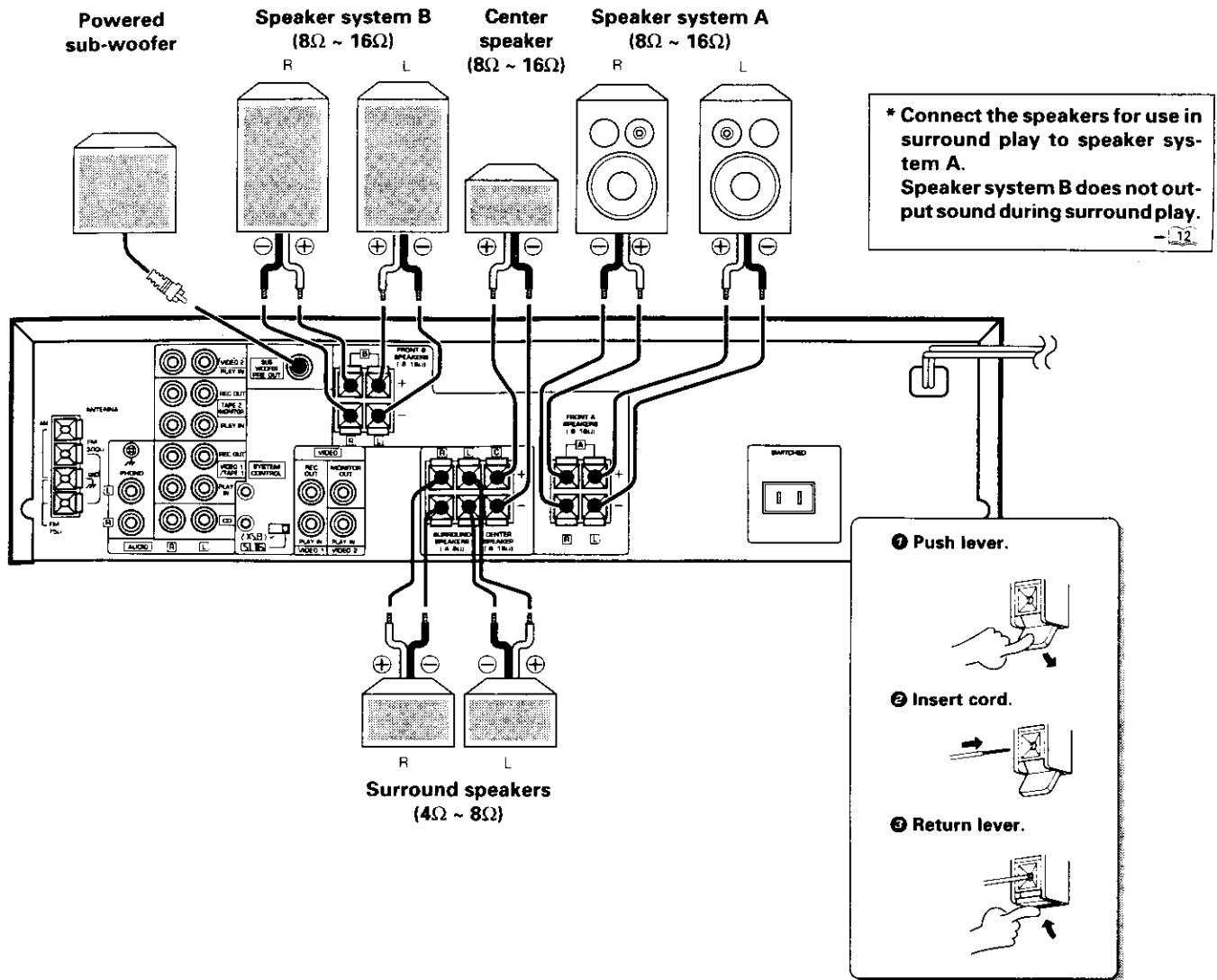

- Never short-circuit the + and - speaker cords. For the symptom and remedy when a speaker cord is shorted. - 28
- If the left and right speakers are connected inversely or if the speaker cords are connected with reversed polarity, the sound becomes unnatural with ambiguous acoustic image positioning. Be sure to connect the speakers and speaker cords correctly.
- Connect a sub woofer if you want to enhance the bass sound. The connected sub-woofer should be a power sub-woofer with a built-in amp.

Connection of antenna

Connection method to each antenna terminal

- ① Push lever.
- ② Insert cord.
- ③ Return lever.

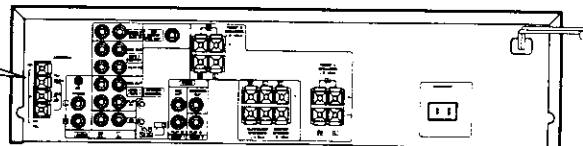
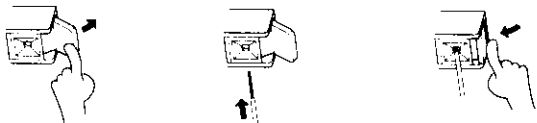

AM loop antenna connection

The supplied antenna is for indoor use. Place it as far as possible from the main system, TV set, speaker cords and power cord, and set it to a direction which provides the best reception.

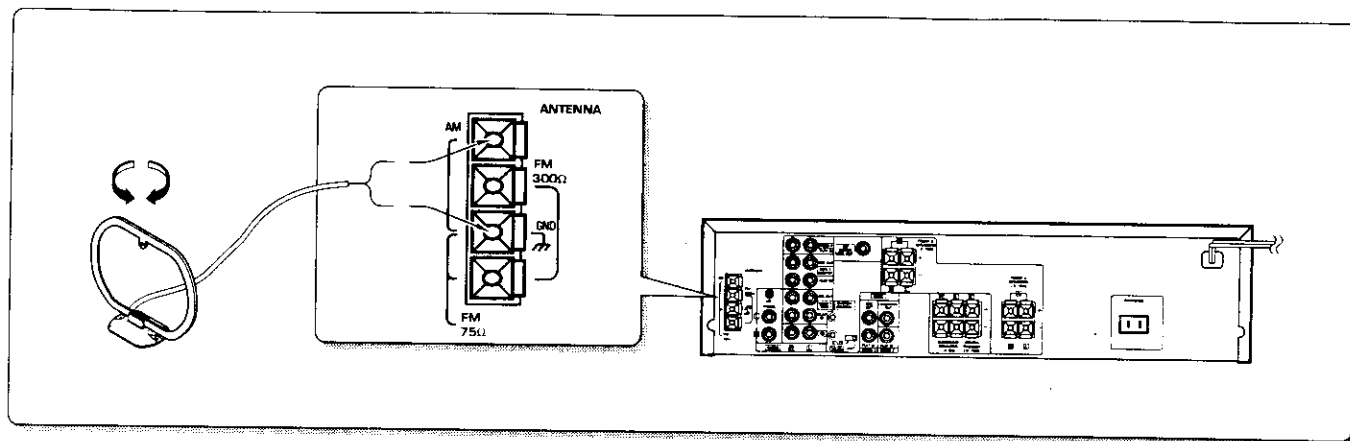

FM indoor antenna connection

The accessory antenna is for temporary indoor use only. For stable signal reception we recommend using an outdoor antenna. Remove the indoor antenna if you connect one outdoors.

FM outdoor antenna connection

Lead the 75 Ω coaxial cable connected to the FM outdoor antenna into the room and connect it to the FM 75 Ω terminal.

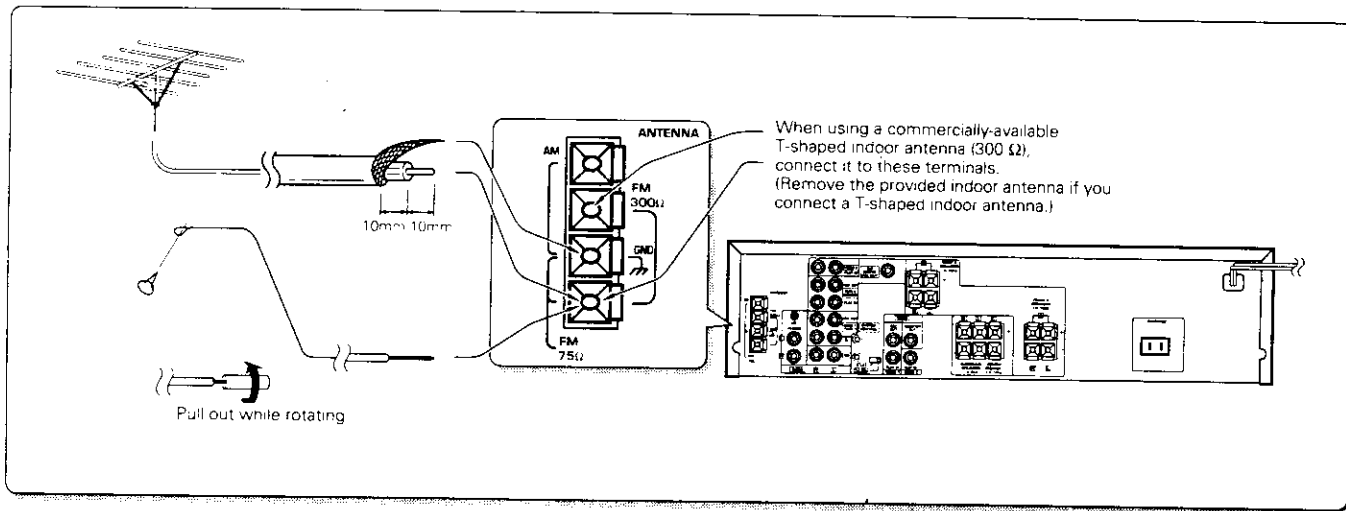

FM DE-EMPHASIS / CHANNEL SPACE switch (Except for U.S.A. and Canada)

The FM DE-EMPHASIS / CHANNEL SPACE switch on the rear panel is set to the correct setting that prevails in the area to which the unit is shipped. However, if the FM DE-EMPHASIS / CHANNEL SPACE setting is not matched to the area where the unit is to be used, for instance, when you moved from area 1 to area 2 or vice versa, desired reception of AM / FM broadcasts is not expected. In this case, change the FM DE-EMPHASIS / CHANNEL SPACE setting in accordance with the area corresponding to the table. The FM DE-EMPHASIS is switched over at the same time.

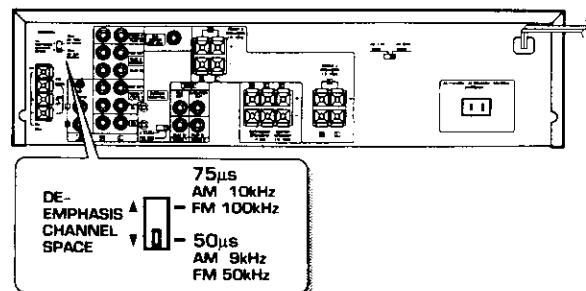

	Area	CHANNEL SPACE freq.	FM DE-EMPHASIS
1	U.S.A., Canada, Hawaii, South American countries	FM: 100kHz AM: 10kHz	75 μ s
2	Other countries	FM: 50kHz AM: 9kHz	50 μ s

- When changing the setting of the FM DE-EMPHASIS / CHANNEL SPACE switch, first disconnect the power cord of the amplifier, then reset the channel space switch, connect the power cord again, and turn the power on.

Controls and indicators

KR-300HT (En/K)

9

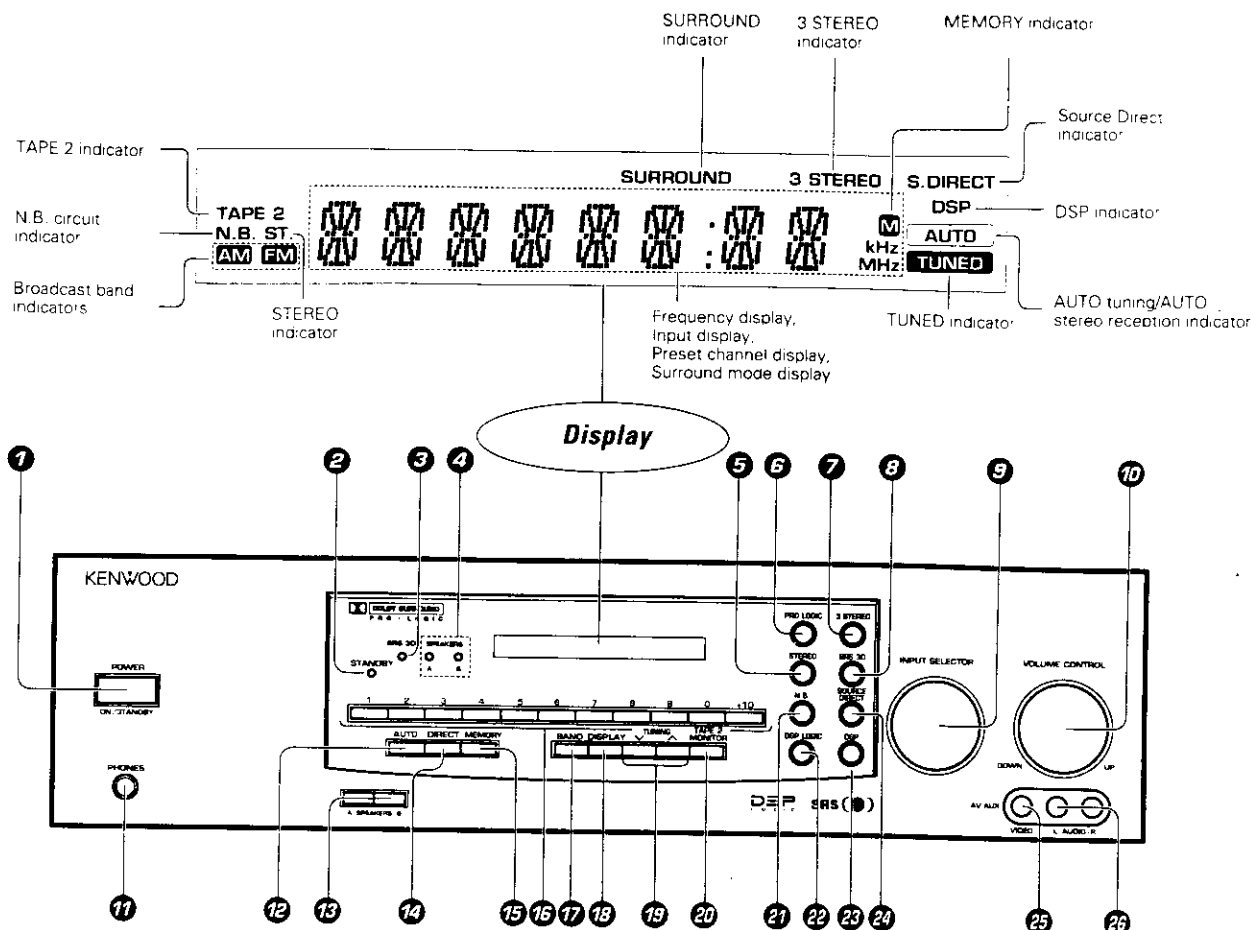

- 1 POWER key**
Press to switch the power ON and OFF.
- 2 STANDBY indicator**
- 3 SRS 3D indicator**
Lights when the SRS 3D system is ON
- 4 SPEAKERS indicator**
Lights when the speakers are ON.
- 5 STEREO key** - 24
Press to turn the surround mode OFF
- 6 DOLBY PRO LOGIC key** - 22
- 7 DOLBY 3 STEREO key** - 24
- 8 SRS 3D key** - 26
- 9 INPUT SELECTOR knob**
Rotate to select the input source
- 10 VOLUME CONTROL knob**
- 11 PHONES jack**
Plug headphones into this jack.
- 12 AUTO key**
Press to select the tuning mode from the auto tuning and manual tuning modes - 17.
Press and hold the **AUTO** key for more than 2 seconds to switch the VIDEO1 display to another input display. - 12
- 13 SPEAKERS A/B keys**
Press to select the A and/or B speakers system.
- 14 DIRECT key** - 18
Press when tuning a broadcast station by entering the digits of its frequencies.
- 15 MEMORY key** - 19
Press when registering a broadcast station in the preset memory.
- 16 Numeric keys (1 to 0, +10)**
- 17 BAND key** - 17
Press to switch the broadcasting band.
- 18 DISPLAY key**
Press to switch the displayed information between the surround mode display and input selector display.
Press and hold the **DISPLAY** key for more than 2 seconds to switch the display brightness.
- 19 TUNING keys (V, ^)** - 17
Press to select a radio station.
- 20 TAPE 2 MONITOR key** - 16
Press to monitor the sound being recorded, etc
- 21 N.B. key** - 14
Press to compensate for the insufficiency in the base sound.
- 22 DSP LOGIC key** - 24
- 23 DSP key** - 23
- 24 SOURCE DIRECT key** - 14
Press to listen to the source sound with a higher sound quality.
- 25 AV AUX (VIDEO) input terminals**
Video input terminal.
- 26 AV AUX (AUDIO) input terminals**
Audio input terminal.

About the STANDBY indicator

This unit has a **STANDBY** indicator, the lighting of which indicates that a small amount of current is supplied to back up the internal memory of the unit. This status is referred to as the standby mode of the unit. In this mode, the power of the unit can be switched ON from the remote control unit. When the unit is not to be used for a long period of time, unplug the power cord from the power outlet.

Operation of remote control unit

KR-300HT (En/K)

Names of keys and their functions

The remote control unit provided with the receiver can also control KENWOOD cassette decks, MULTIPLE CD player and MD recorder connected to the receiver through system control cords. For details of the controllable functions, refer to the instruction manuals of these components.

Model: RC-R0505
Infrared ray system

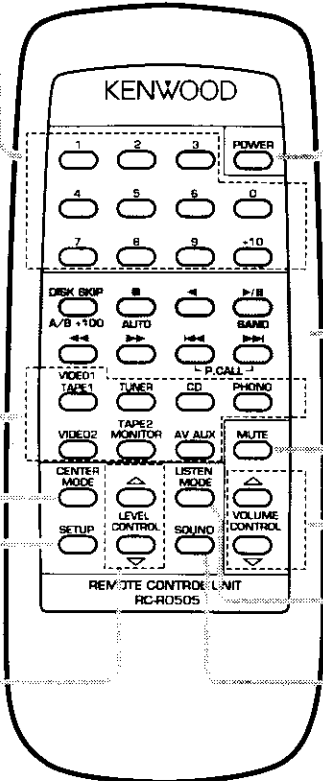

Numeric keys
Used as the numeric keys of the input source component being selected.

INPUT keys
Press to select the input.

CENTER MODE key - 22
Press to select the center mode in the DOLBY PRO LOGIC surround mode.

SETUP key - 13 - 22
Press to set up the balance or surround play.

LEVEL CONTROL keys - 13 - 22
Press to adjust the tone or during setup of the surround mode.

POWER key
Press to switch ON/OFF the power of this unit as well as the KENWOOD components connected to it through system control cords.

Refer to the remote control key correspondence table on the next page.

MUTE key
Press to mute sound temporarily.

VOLUME CONTROL keys
Press to adjust the volume.

LISTEN MODE key - 24 - 25
Press to select the type of the surround mode.

SOUND key - 13 - 26
Press to adjust the tone.

Remote Control Unit Labels:
KENWOOD
1 2 3 POWER
4 5 6 0
7 8 9 -10
DISK STOP A/B +100 AUTO P/B BAND
VIDEO1 TAPE1 TUNER CD PHONO P.CALL
VIDEO2 TAPE2 MONITOR AV ALX MUTE
CENTER MODE LISTEN MODE
SETUP LEVEL CONTROL SOUND VOLUME CONTROL
REMOTE CONTROL UNIT RC-R0505

Loading batteries

① Remove the cover.

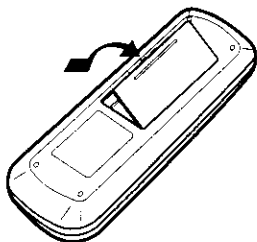

② Insert batteries.

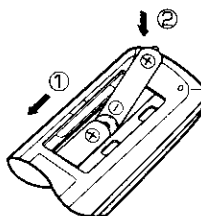

● Insert two AA-size (R6 / SUM-3) batteries as indicated by the polarity marking.

③ Close the cover.

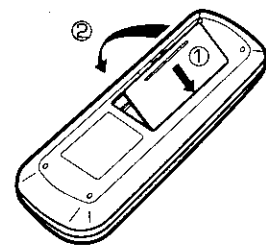























Operation procedure

- 1** Switch ON the power of the main unit.
- 2** Select the component to be remote controlled with one of the controlled component selection keys.
- 3** Refer to the remote control key correspondence table below and press the key for the desired operation.

- Pressing the **POWER** key of the remote control unit while the **STANDBY** indicator is lit turns the power ON. Press the desired key after the power has been turned ON.
- When two operation keys of the remote control unit are pressed successively, press each key securely reserving an interval of more than 1 second for each press.

Remote control key correspondence table (For KENWOOD component control mode)

Controlled component selection key Operation key	TUNER 	CD 	TAPE1 	*1 TAPE1  (When used with a MD)
 P.CALL Recalls preset stations.	P.CALL keys Recalls preset stations.	 (Skip key)	—	 (Skip key)
 AUTO Press to select the auto tuning mode.	AUTO key Press to select the auto tuning mode.	 (Stop key)	 (Stop key)	 (Stop key)
 DISK SKIP A/B +100	—	DISC SKIP key Press to select the disc to be played	A/B key Select TAPE A or B.	+100
 BAND Press to switch the broadcast band.	BAND key Press to switch the broadcast band.	 (Play/pause key)	 (Forward play key)	 (Play key)
 (Tuning keys) Press to tune broadcast stations	 (Tuning keys) Press to tune broadcast stations	 (Search key)	 (Search key)	 (Search key)
 (Reverse play key)	—	—	 (Reverse play key)	—

Approximate operating range

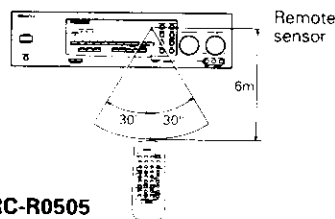

- *1: No remote control key is marked MD, but the **TAPE1** key can be used to control a MD player by switching the display of the main unit from **VIDEO1** to **TAPE1** then to **MD**.



1. The supplied batteries are intended for use in operation checks. Therefore, their lives may be shorter than ordinary batteries.
2. When the remote-controllable distance gets shorter than before, replace both batteries with new ones.
3. Malfunction may occur if direct sunlight or the light of a high-frequency lighting fluorescent lamp enters the remote control light sensor. In such a case, change the system installation position to prevent the malfunction.

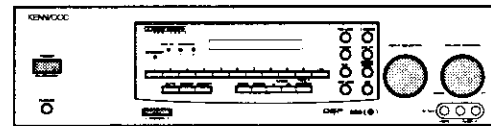
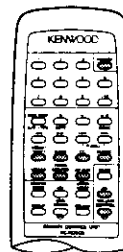

: Keys or controls to be used in this operation

1 Turn the power ON.

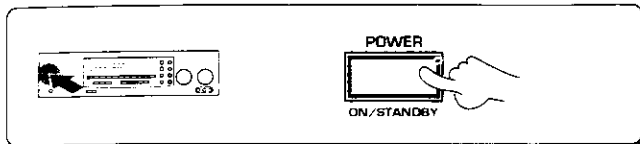

2 Select the SPEAKERS key setting.

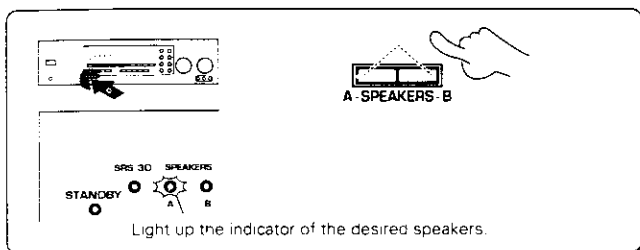

3 Select the input source.

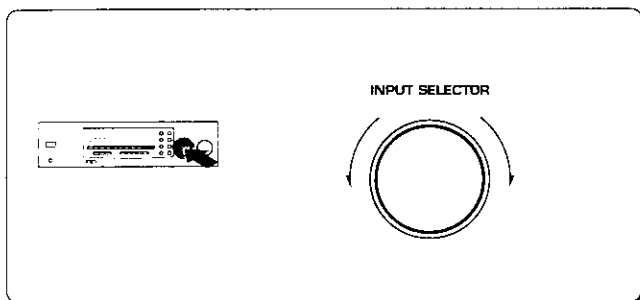

4 Play the selected source.

5 Adjust the volume.

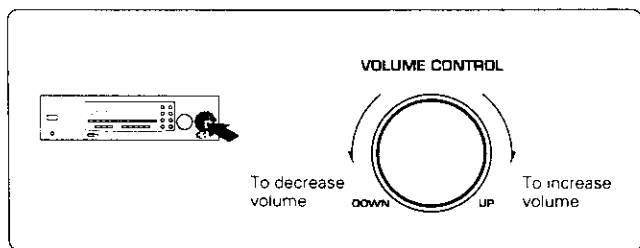

Note The sound output from **SPEAKERS A** and **SPEAKERS B** can be switched by operating the **SPEAKERS A** and **B** keys as described below.

For the speaker connection method: 6

- A, B OFF** : The speakers do not output sound. Use this position when listening sound through headphones, etc.
- A ON** : The speakers connected to the **SPEAKERS A** terminals on the rear panel output sound.
- A OFF** : The speakers connected to **SPEAKERS A**, center speaker and sub-woofer do not output sound.
- B ON** : The speakers connected to the **SPEAKERS B** terminals on the rear panel output sound.
- A, B ON** : The speakers connected to the **SPEAKERS A** and **B** terminals on the rear panel output sound simultaneously.

- When the surround mode is entered while both **SPEAKERS A** and **B** are **ON**, **SPEAKERS B** are turned **OFF** automatically. If the **SPEAKERS B** key is pressed at this time, **SPEAKERS B** are turned **ON**, and the surround mode is canceled.
- When the surround mode is entered while **SPEAKERS B** are **ON**, **SPEAKERS B** are turned **OFF** automatically, **SPEAKERS A** are turned **ON** and surround play starts.

The input sources are switched in the following order:

- ① **TUNER** (frequency display)
 - ② **PHONO**
 - ③ **VIDEO1** (TAPE 1 or MD)*1
 - ④ **CD**
 - ⑤ **VIDEO2**
 - ⑥ **AV AUX**
- The selected source is displayed.
-

*1: Switching the VIDEO1 display to TAPE1 or MD display

When a KENWOOD cassette deck or MD recorder is connected in the [SL16] system control mode, the VIDEO 1 input should be switched to the TAPE1 or MD input with the following operation.

- ① Select **VIDEO1** with the **INPUT SELECTOR**.
- ② Press and hold the **AUTO** key for more than 2 seconds to select **TAPE1** or **MD**.

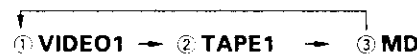

Volume level is displayed

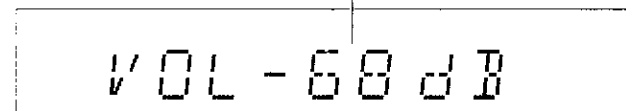

- The time taken till the volume level is displayed is variable depending on the current operating condition.
- Rotating the **VOLUME CONTROL** at a higher speed increases the amount of volume change (AI VOLUME function).
- The sound of input source cannot be listened to while **TAPE 2 MONITOR** is **ON**.

Sound adjustment functions

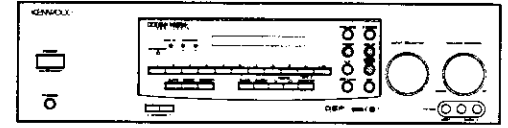
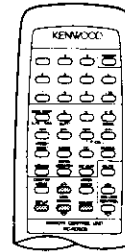

: Keys or controls to be used in this operation

Adjusting the tone

❶ Ensure that the SRS 3D and S.DIRECT indicators are not lit.

❷ Select the tone mode to be adjusted (from BASS, MIDDLE and TREBLE).

❸ Adjust the tone

To increase level

To decrease level

The level can be adjusted between -8 and +8 with an increment or decrement of 2 per press.

SRS 3D S.DIRECT Make sure that the light is out.

- If the S.DIRECT indicator is lit, press the **S.DIRECT** key to turn it off.
- If the SRS 3D indicator is lit, press the **SRS 3D** key to turn it off.

Each press of the key switches the modes as follows:
(When the SRS 3D Stereo is OFF)

- ① **BASS** : Mode for adjusting the low frequencies.
- ② **MIDDLE** : Mode for adjusting the middle frequencies.
- ③ **TREBLE** : Mode for adjusting the high frequencies.
- ④ End of setting

• Adjustment of SRS(Sound Retrieval System) 3D Stereo - 26

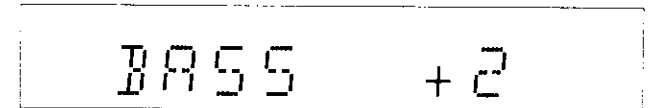

Display when "BASS" is selected.

The displayed value changes.

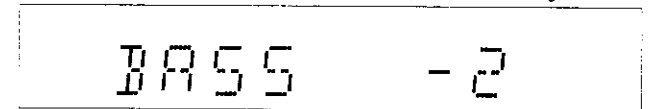

Adjusting the left/right sound balance

❶ Ensure that the SURROUND, 3 STEREO and S.DIRECT indicators are off.

❷ Press the SETUP key twice.

❸ Adjust the balance.

To decrease the left channel sound

To decrease the right channel sound

❹ Press the SETUP key once or twice to return to the previous input selector display.

SURROUND 3 STEREO S.DIRECT Make sure that the light is out.

• If the SURROUND, 3STEREO or S.DIRECT indicators are lit, press the **STEREO** key to turn them OFF.

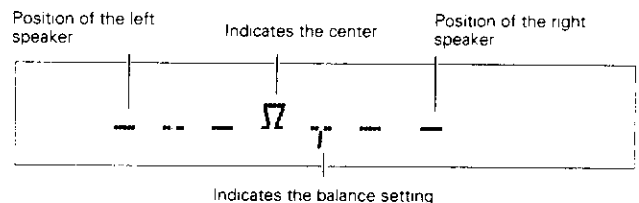

• Press twice if SUB-WOOFER has been set.
Press once if SUB-WOOFER has not been set.
For how to set SUB-WOOFER

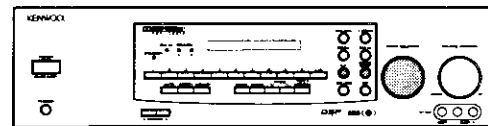
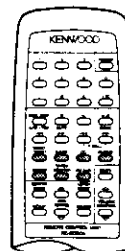

 : Keys or controls to be used in this operation

Source Direct playback

This feature allows you to play the source signal with a high quality by passing it only through the minimum required circuitry

1 Choose the playback source.

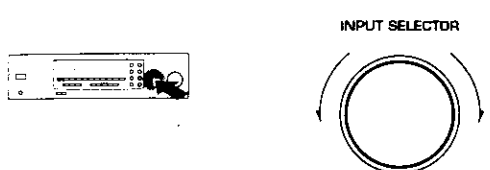

2 Press the SOURCE DIRECT key.



3 Playback the source.



- During Source Direct playback, the tone controls (BASS, MIDDLE and TREBLE), balance control and N.B. are defeated.
- The Source Direct playback is canceled when any key associated with the surround play is pressed.

To cancel

Press the SOURCE DIRECT key again.

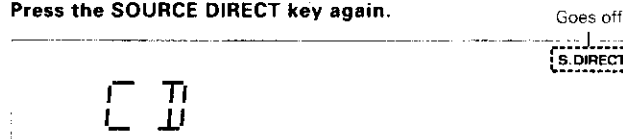

Compensating for low frequencies (N.B.: Natural Bass circuit)

N.B. circuit is used to compensate for the low frequencies which are less audible during low-volume listening.



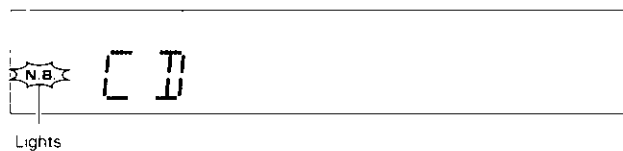



- When the S.DIRECT is selected, the N.B. control keys are not effective.

To cancel

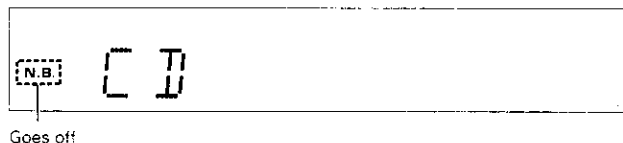
Press the N.B. key again.

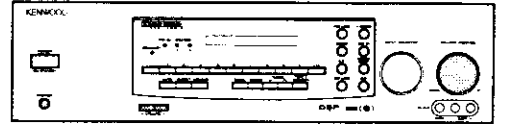
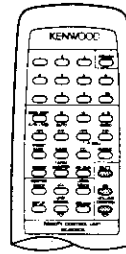



 : Keys or controls to be used in this operation

To listen through headphones

1 Press the SPEAKERS key to OFF.



2 Plug headphones.

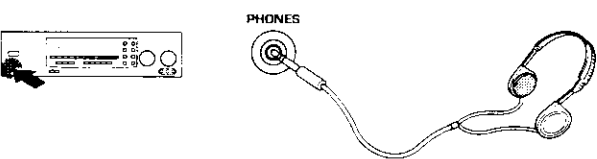

3 Adjust the volume.

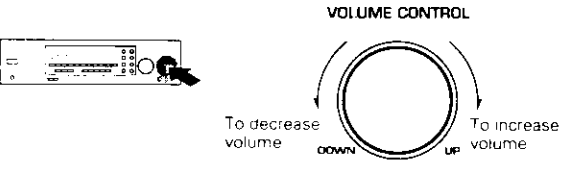
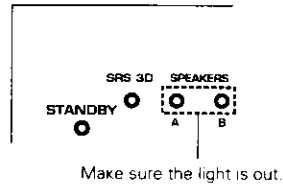
To mute sound temporarily

Remote control unit only

To cancel
Press the MUTE key again.

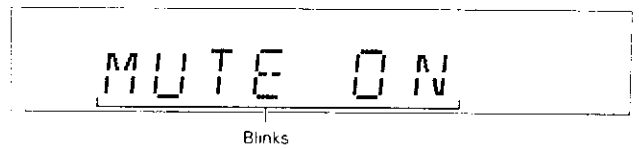
Recording

KR-300HT (En/K)

When recording sound with a recorder component of KENWOOD, synchro recording is possible by setting the INPUT SELECTOR to select TAPE1 or MD according to the connected component.

Preparation

● Switch the VIDEO1 display to TAPE1 or MD with the following operation.

- 1 Select VIDEO1 with the INPUT SELECTOR.
- 2 Press and hold the AUTO key for more than 2 seconds.

Each press switches the display.

① VIDEO1 → ② TAPE1 → ③ MD

To record a music source

- 1 Select the source to be recorded.

INPUT SELECTOR



Select an input source other than TAPE 1

- 2 Put the cassette deck in record-pause mode.

- 3 Play the source and start recording.

The input sources are switched in the following order:

- 1 TUNER (frequency display)
- 2 PHONO
- 3 VIDEO1 (TAPE1 or MD)
- 4 CD
- 5 VIDEO2
- 6 AV AUX

- The VIDEO1 display can be switched to the display of other input by using the procedure described in "Preparation" above.
- For the synchro recording with a cassette deck and/or MD recorder, refer to the respective instruction manuals.
- It is not possible the VIDEO1 or MD input to TAPE1 because all of these components should use the same INPUT SELECTOR position.

Copying tape (Tape dubbing TAPE 2 → TAPE 1)

- 1 Press the TAPE 2 MONITOR key.



BAND DISPLAY TUNING TAPE2 MONITOR

- 2 Select a source other than TAPE 1.

INPUT SELECTOR



- 3 Play cassette deck 2 and start recording on cassette deck 1.



- For copying a tape using a double cassette deck, read the instruction manual of the double cassette deck.

Copying tape (Tape dubbing TAPE 1 → TAPE 2)

- 1 Select TAPE 1 with the INPUT SELECTOR control of the main unit.

- 2 Play the cassette deck connected to the TAPE 1 jacks and start recording of the cassette deck connected to the TAPE 2 jacks.

Regarding TAPE 2 MONITOR

A cassette deck or graphic equalizer can be connected to this unit's TAPE 2 MONITOR terminals. If you connect a graphic equalizer, turn the TAPE 2 MONITOR key ON. If you connect a 3-head cassette deck, you can monitor the source sound, or the sound being recorded, while recording. Pressing the TAPE 2 MONITOR key lets you compare the recorded sound and the source sound. Refer to the operating manual for the component you connected for further details.

Broadcast reception

KR-300HT (En/K)

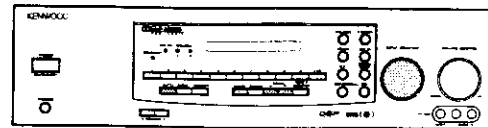
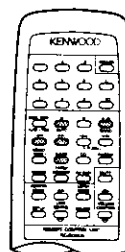

Keys or controls to be used in this operation

Receiving broadcast stations

1 Select the TUNER input.

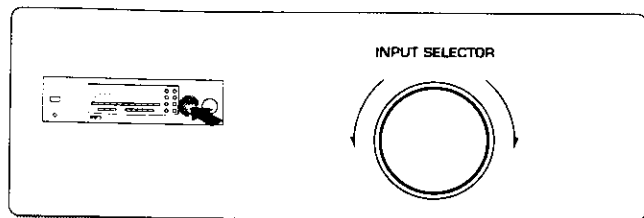

The input sources are switched in the following order:

- ① TUNER (frequency display)
- ② PHONO
- ③ VIDEO1 (TAPE1 or MD)*¹
- ④ CD
- ⑤ VIDEO2
- ⑥ AV AUX



• The last frequency tuned before is displayed.

• *¹: How to switch the display

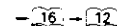

2 Select the broadcast band.

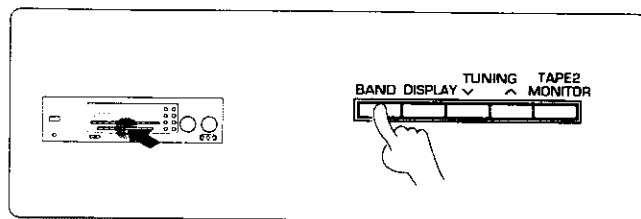

Each press switches the band as follows:

- ① FM
- ② AM

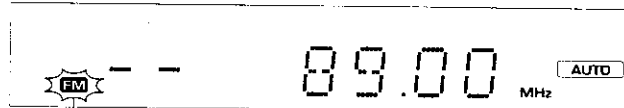

"AM" or "FM" indicator

3 Select the tuning method.

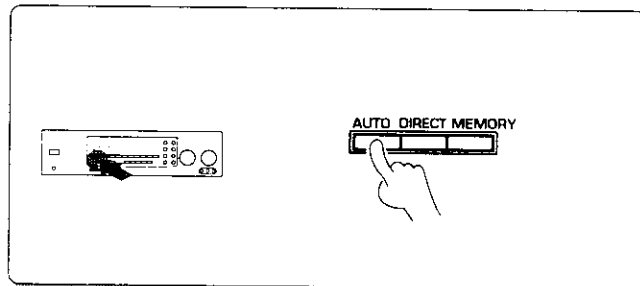

Each press switches the tuning method as follows:

- ① AUTO lit (auto tuning)
- ② AUTO not lit (manual tuning)



• Usually, set the switch to **AUTO** (auto tuning).

Select manual tuning when noise interferes due to weak radio wave. (The stereo broadcasting is received in monaural during manual tuning.)

4 Select a station.

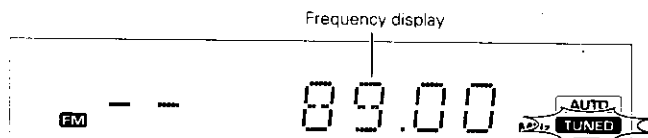
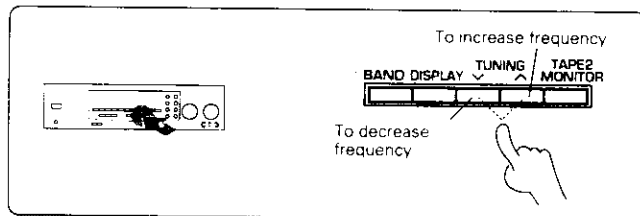

"TUNED" lights up when a station is tuned.

Auto tuning : The next station found is tuned automatically.
Manual tuning : Press repeatedly or hold until a station is tuned.

• The same operation is also available with the and keys of the remote control unit.

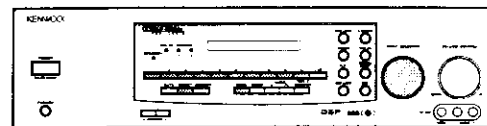
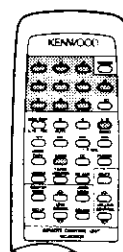

 : Keys or controls to be used in this operation

Receiving radio stations by specifying its frequency

1 Select the TUNER input.

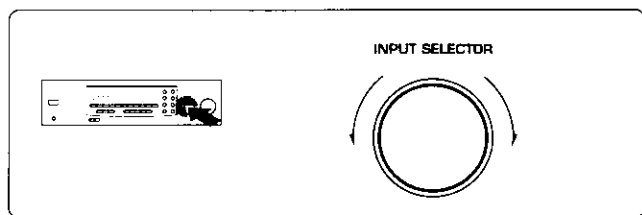

The input sources are switched in the following order:

- ① TUNER (frequency display)
- ② PHONO
- ③ VIDEO1 (TAPE1 or MD)
- ④ CD
- ⑤ VIDEO2
- ⑥ AV AUX

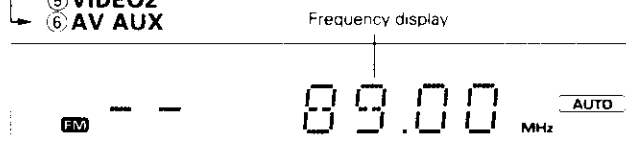

2 Select the broadcast band.

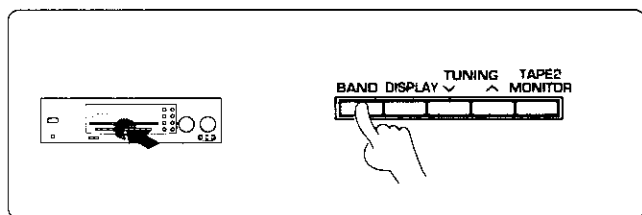

Each press switches the band as follows:

- ① FM
- ② AM



"AM" or "FM" indicator

3 Specify the frequency.

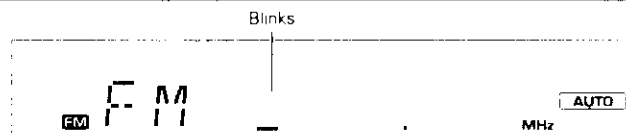
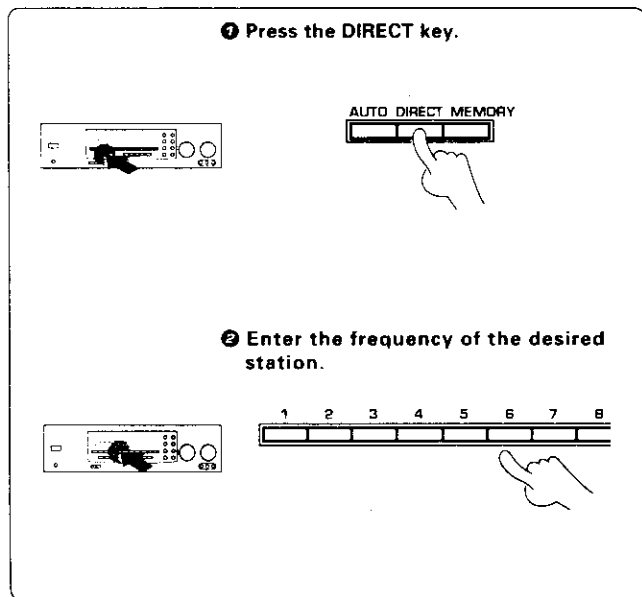

Press the numeric keys according to the frequency to be tuned as shown below.

* AM10kHz/FM100kHz territories (U.S.A., Canada, etc.)

- | | | | | |
|-------------|-------|--------------------------------|--|-----------------|
| AM 810 kHz | | 8 , 1 | | (10 kHz space) |
| AM 1260 kHz | | 1 , 2 , 6 | | (10 kHz space) |
| FM 89 MHz | | 8 , 9 , 0 | | (100 kHz space) |
| FM 92.5 MHz | | 9 , 2 , 5 | | (100 kHz space) |

* AM9kHz/FM50kHz territories (other countries)

- | | | | | |
|-------------|-------|---|--|-----------------|
| AM 810 kHz | | 8 , 1 , 0 | | (9 kHz space) |
| AM 1260 kHz | | 1 , 2 , 6 , 0 | | (9 kHz space) |
| FM 89 MHz | | 8 , 9 , 0 , 0 | | (50 kHz space) |
| FM 92.5 MHz | | 9 , 2 , 5 , 0 | | (50 kHz space) |

* FM DE-EMPHASIS/CHANNEL SPACE switch

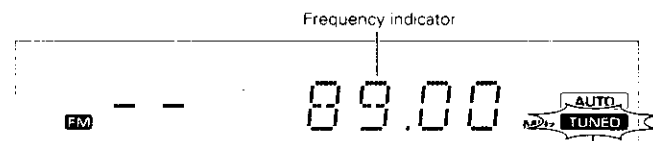

"TUNED" lights up when a station is tuned.

● If you make a mistake, the frequency display blinks for a few seconds. In this case, repeat step 2 from the beginning.

Preparation • Select the TUNER input.

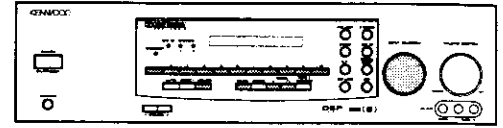
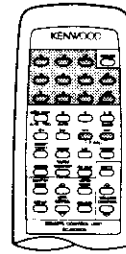

: Keys or controls to be used in this operation

Storing radio stations in memory (Station preset)

- ❶ Select the receiving band.
- ❷ Select a station or frequency.
- ❸ Press the MEMORY key during receiving a station.



AUTO DIRECT MEMORY



Proceed to step ❹ within 5 sec.

(If more than 5 sec. have elapsed, press the MEMORY key again.)

- ❹ Select one of the preset numbers from 1 to 30.

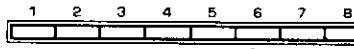

Blinks (for 5 sec.)

Blinks (for 5 sec.)

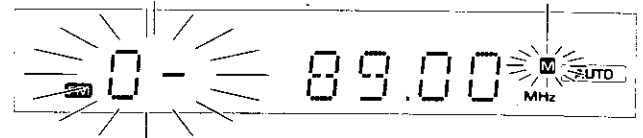

Press the numeric keys in the following order.

To store in "15" ... **+10**, **5**

To store in "20" ... **+10**, **+10**, **0**

- Repeat steps ❶ ~ ❹ for each of the stations to be stored in memory.
- If a station is stored in a preset number which has already stored a station memory under it, the previous memory is replaced by the new memory content.

Receiving a preset station

Press the preset number of the desired station.

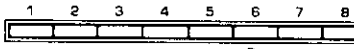

Press the numeric keys in the following order.

To recall "15" ... **+10**, **5**

To recall "20" ... **+10**, **+10**, **0**

- If you make a mistake in entering the figure of 10, press the **+10** key repeatedly until the original display is shown, then enter the correct number.

Preset number stored in memory

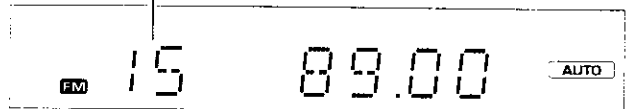

Receiving all preset stations in order (P. CALL)



The preset number decreases

The preset number increases



- Every time the key is pressed, the next station in the order of the preset number is received.

When you press **P. CALL** key, 1 → 2 → 3 28 → 29 → 30

When you press **P. CALL** key, 1 → 2 → 3 28 → 29 → 30

If the key is held pressed Preset stations will be received successively for about half a second each.

Operation of video components

KR-300HT (En/K)

For the connections and operations, also read carefully the instruction manuals of the video components.

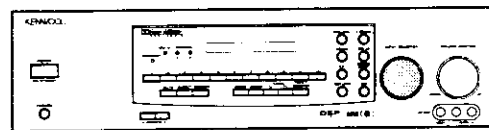
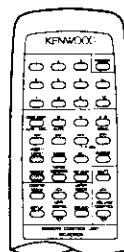

 : Keys or controls to be used in this operation

Playback of videotape

1 Turn the power of the monitor TV ON.

2 Select the VIDEO1, VIDEO2 or AV AUX input.

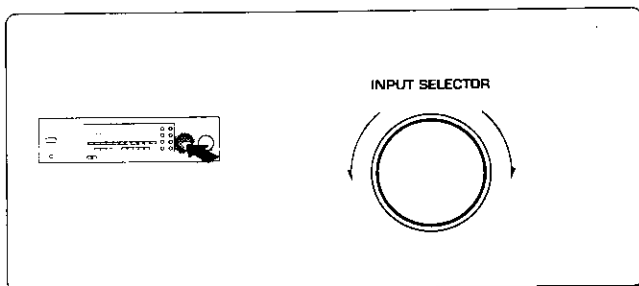

The input sources are switched in the following order:

- ① TUNER (frequency display)
- ② PHONO
- ③ VIDEO1 (TAPE1 or MD)*1
- ④ CD
- ⑤ VIDEO2
- ⑥ AV AUX

"VIDEO1", "VIDEO2" or "AV AUX" should be displayed.

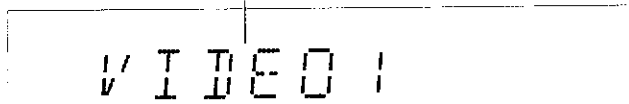

- Select the input to which a video deck is connected.
- *1: How to switch the display - 12 - 16
- For the operations of the monitor TV and video deck, refer to their instruction manuals.

3 Play the video deck.

Recording of video source (VIDEO 2 / AV AUX → VIDEO 1)

1 Connect the video source component to be played.

2 Select the VIDEO2 or AV AUX input.

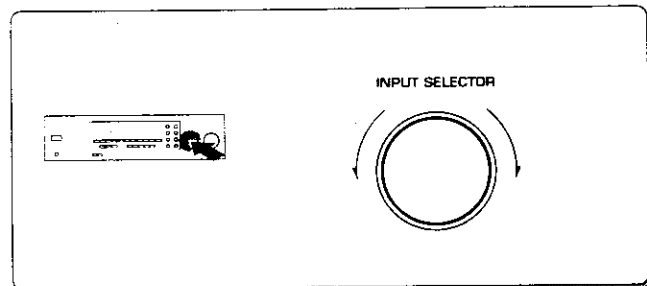

- Connect the component to be played to the VIDEO 2 or AV AUX jacks.
- The connectable components include a video deck (playback only), video camera (playback only), LD player or DBS tuner.

The input sources are switched in the following order:

- ① TUNER (frequency display)
- ② PHONO
- ③ VIDEO1 (TAPE1 or MD)*2
- ④ CD
- ⑤ VIDEO2
- ⑥ AV AUX

"VIDEO2" or "AV AUX" should be displayed.

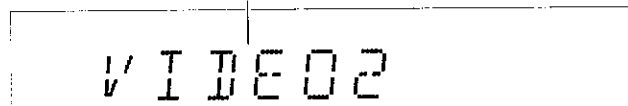

- *2: Select VIDEO1.
- *2: For the display switching method: - 12 - 16

3 Play the source component.

4 Start recording on the recording video deck.

- Start recording with the video deck which is connected to the VIDEO 1 jacks.

Presence play

The surround modes allow you to enjoy the feeling of presence in music. Select the mode according to the source or components played. For the connections of the surround and/or center speakers, refer to "Connection of speakers".

DOLBY PRO LOGIC surround mode

Video, DVD and LD software programs carrying the  mark contain recording of the same Dolby Surround data as those used in movie theaters. The DOLBY PRO LOGIC surround mode uses the Dolby Surround data and brings into home a similar sound field with full of presence to movie theaters. To use this mode, connect the surround (and center) speakers.

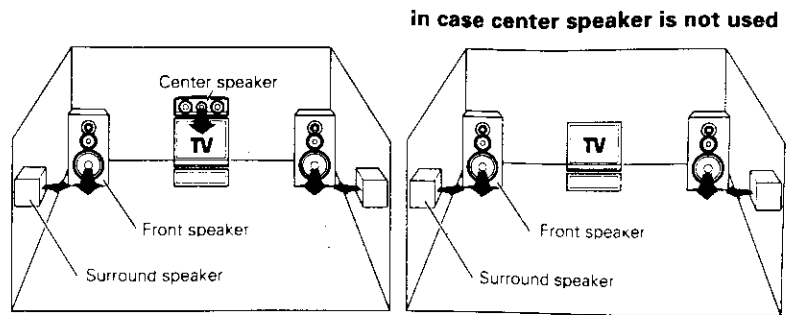

DOLBY 3 STEREO mode

If the left and right speakers are installed apart from each other, the center acoustic image (words, etc.) may vary depending on the listener's position. The DOLBY 3 STEREO mode provides an improved positioning of the center acoustic image regardless of the listening position. Use this mode when playing videotape, DVD or LD software carrying the  mark. To use this mode, connect the center speaker.

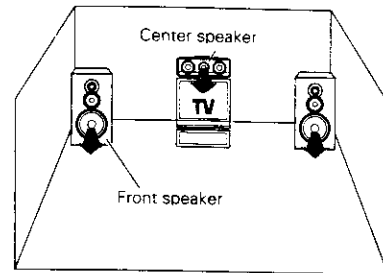

DSP LOGIC mode

DSP LOGIC lets you enjoy the atmosphere of a movie theater in your listening room. By adding the reverberation aspects of a movie theater to the sound from the original music source, you can enjoy the soundscape of either a LARGE or SMALL movie theater. Be sure to connect surround and center speakers when using this mode.

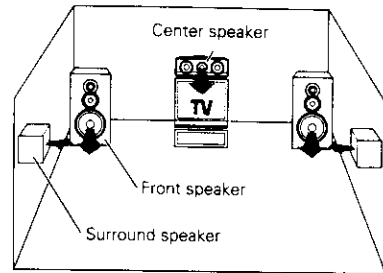

DSP presence mode

This mode provides a live atmosphere to music sources. By adding the reverberation component of one of the three sound fields of this mode, it allows to enjoy three kinds of sound fields (ARENA, JAZZ CLUB, STADIUM) with full of feeling of presence. The sound field can be selected according your liking. To use this mode, connect the surround speakers.

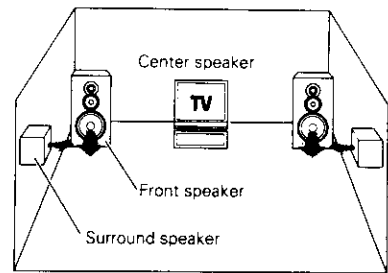

Recommended speaker installation



It is recommended that the surround speakers are installed straight to the left and right of the listening position or slightly behind, at a height of about 1 meter higher than the listener's ears. Each surround speaker should be installed so that the longer sides are horizontal.

What is DSP?



The DSP stands for Digital Signal Processor. In the DSP presence and DSP LOGIC modes, the reverberation components (elements of sound echoed in various spaces) which determine the feeling of presence are created by digital processing by the DSP without spoiling the sound quality of the original music source.

To improve the feeling of presence in the surround modes, various parameters of each surround mode can be set up according to the speaker system used as well as to the environmental of the listening room. The following procedure let you set the parameters of the surround mode (DOLBY PRO LOGIC, DOLBY 3 STEREO).

Once the settings have been done, it is held in memory so re-adjustment is not necessary even after the mode has been changed to other modes.

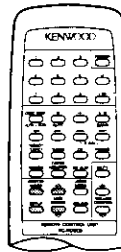

Keys or controls to be used in this operation

Adjustments for surround play

1 Select the DOLBY PRO LOGIC surround mode.

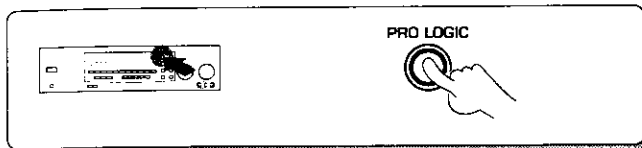

- Select a surround mode according to the played source and your system components.

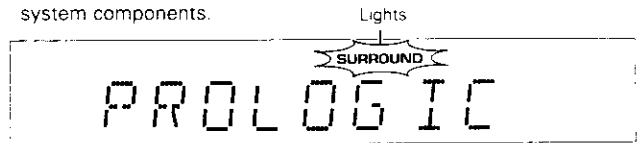

2 Select the CENTER MODE.

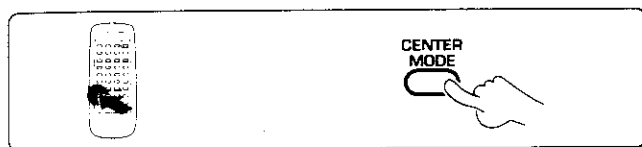

The input sources are switched in the following order:

- NORMAL** : When the center speaker is a compact speaker.
- WIDEBAND** : When the center speaker is a large speaker.
- PHANTOM** : When no center speaker is used.

3 Set the sub-woofer.

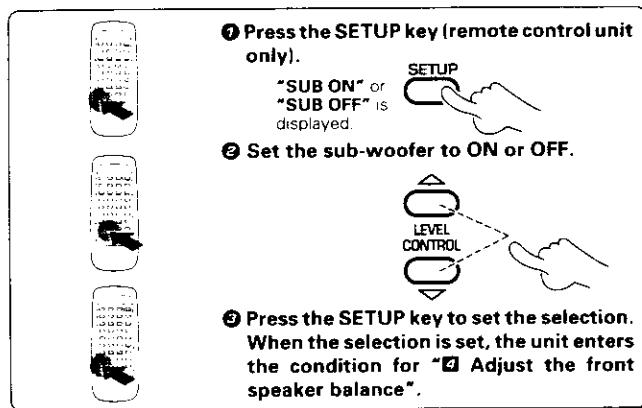

Adjustment procedure: Each press of the **SETUP** key switches the adjusted items as shown below.

- Setting the sub-woofer
 - Adjusting the front speaker balance
 - Adjusting the volume level of each speaker
 - Adjusting the delay time
- End of setup

To cancel setup in the middle, press the **SETUP** key repeatedly until the setup mode is cancelled.

Each press switches the sub-woofer as follows.

- SUB ON** : Sub-woofer ON
- SUB OFF** : Sub-woofer OFF

4 Adjust the front speaker balance.

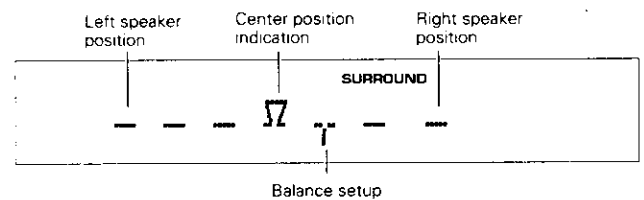
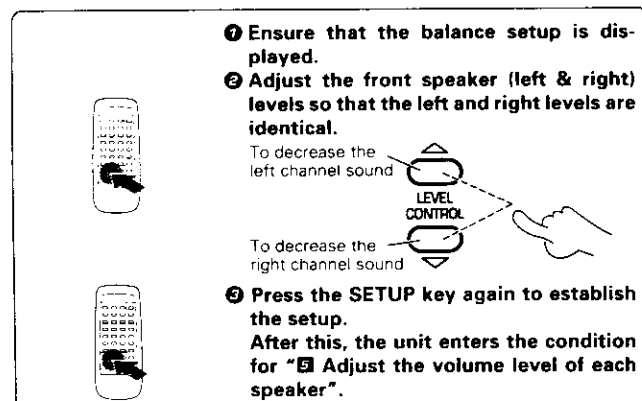

How to calculate the proper delay time

Assuming that the distance from the front speakers is A meters and that from the surround speakers is B meters:

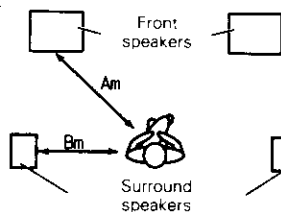

① Use the delay time calculation chart on the right.

Example:
When A = 3 m, B = 3 m,
the delay time is 20 ms.

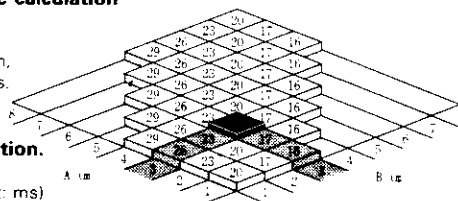

② Use the following formula for calculation.

Delay time =
 $20 + 3 \times (A - B)$ (Unit: ms)

What is delay time?



The sound entering the ears include the direct sound coming from the sound source and the indirect sounds reflected from the walls, floor, ceiling, etc. The indirect sounds are delayed because they travel longer distance required for reflection before they reach the ears. The delay time is the difference in time between the direct sound and indirect sounds.

5 Adjust the volume level of each speaker.

① Ensure that "TEST L" is displayed. Test tone will be output from each speaker.

② Adjust the volume levels of the center speaker, surround speakers and sub-woofer with reference to the front speaker (left & right) levels.

(1) While test tone is output from the speaker(s) to be adjusted,
(2) Adjust the speaker level.

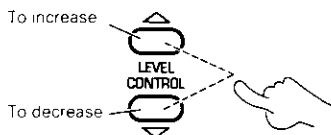

③ After having adjusted all of the speaker levels, establish the setup.



After this, the unit enters the condition for "Adjust the delay time".

• Noise-like test tone moves across speakers at intervals of 1.5 seconds.

- TEST L (Front speaker, left)
- TEST C (Center speaker)
(Only when **NORMAL** or **WIDE BAND** is selected in step 2)
- TEST R (Front speaker, right)
- TEST S (Surround speakers)
(Only when **PRO LOGIC** is selected in step 1)
- TEST SUB (Sub-woofer)
(Only when **SUB ON** is selected in step 3)

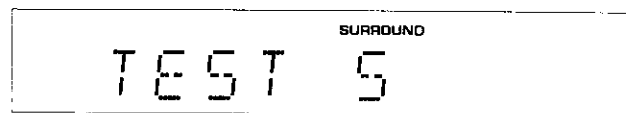

Display when test tone is output from surround speakers

- Be sure to adjust from the listening position.
- Each press of a **LEVEL CONTROL** key varies the level by 1 dB.
- The volume level can be adjusted in the range from -10 to +10 dB.
But the sub-woofer level can be adjusted in the range from -20 to +10 dB.
- The front speaker (left & right) levels cannot be varied with the **LEVEL CONTROL** keys.
- Adjust the volume level from each of the center speaker, surround speakers and sub-woofer while test tone it output from the corresponding speaker.

6 Adjust the delay time.

① Ensure that the delay time adjustment display is displayed.

② Adjust the delay time.

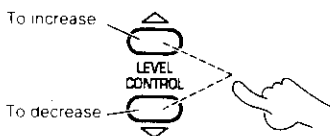

③ Establish the setup.

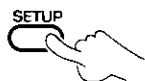

This is the end of setup (the unit returns to the condition before starting the setup operations).

- Check the proper delay time for your listening room by referring to "How to calculate the proper delay time".
- The delay time can be adjusted to 15, 20, 25 or 30 ms.
- Select an integer value which is closest to the value obtained with "How to calculate the proper delay time".

For the delay time setting of the DSP LOGIC and DSP presence modes, refer to -25.

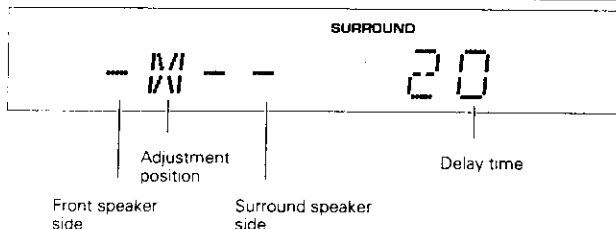

When playing videotape (DVD or LD) software carrying the  mark, a sound field with enhanced surround effects can be enjoyed by using the DOLBY PRO LOGIC or DOLBY 3 STEREO mode.

Other surround modes can also be used effectively with any kind of source.

Be sure to complete "Adjustments for surround play" prior to starting playback in one of these surround modes.

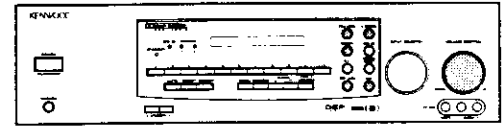
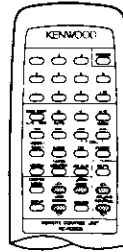

 Keys or controls to be used in this operation

Surround play

1 Select one of the surround modes.

1 Select the desired surround mode.



2 Select the desired sound field.
(This step is required only when "DSP" or "DSP LOGIC" is selected in 1 above.)



2 Play a video software program.

3 Adjust the volume.

Each press of **LISTEN MODE** key switches the modes as follows:

- 1 **STEREO**
- 2 **PRO LOGIC**
- 3 **3 STEREO**
- 4 **DSP**
- 5 **DSP LOGIC**

• The surround modes can also be selected directly using the corresponding keys on the main unit.

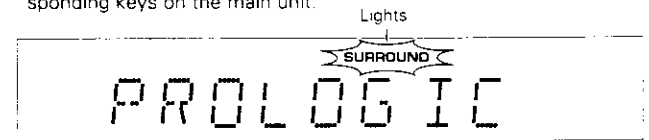

Example when **DOLBY PRO LOGIC** is selected

For DSP mode

- 1 **ARENA** : Reproduces the feeling of sitting in the front row of an arena concert.
- 2 **JAZZ CLUB** : Reproduces crisp cymbal crashes like at a jazz club.
- 3 **STADIUM** : Reproduces a feeling of release associated with the near absence of reverberation reflected from the ceiling.

For DSP LOGIC mode

- 1 **LARGE** : Reproduces the presence of a large movie theater.
- 2 **SMALL** : Reproduces the presence of a relatively small movie theater.

- To change the sound field, repeat step 1 from the beginning.
- The center speaker does not output sound when the DSP mode is selected.

To cancel the SURROUND play

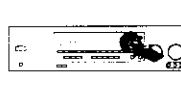

STEREO



Main unit



LISTEN MODE



Remote control unit

On the remote control unit, the following modes are switched every time the **LISTEN MODE** key is pressed.

- 1 **STEREO**
- 2 **PRO LOGIC**
- 3 **3 STEREO**
- 4 **DSP**
- 5 **DSP LOGIC**

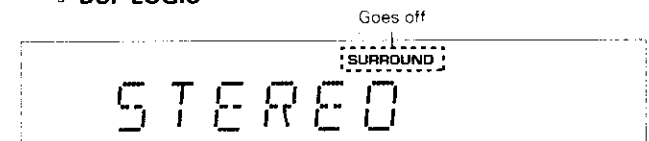

Manufactured under licence from Dolby Laboratories Licensing Corporation.
"Dolby", "Pro Logic" and the double - D symbol are trademarks of Dolby Laboratories Licensing Corporation.

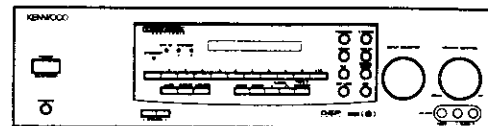
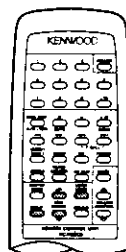

 : Keys or controls to be used in this operation

Adjusting the surround effects (DSP presence and DSP LOGIC modes only)

Adjust the delay time.



1 Select "DSP" or "DSP LOGIC".



2 Select "DELAY".



3 Adjust.
(How to calculate the proper delay time)

To increase  **LEVEL CONTROL** 

To decrease

Each press of **LISTEN MODE** key switches the modes as follows:

- 1 **STEREO**
- 2 **PRO LOGIC**
- 3 **3 STEREO**
- 4 **DSP**
- 5 **DSP LOGIC**

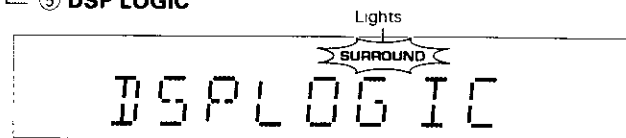

Display when **DSP LOGIC** mode is selected

Each press of **SETUP** key switches the modes as follows:

- 1 **SUB ON/OFF** Switch
- 2 **BALANCE** Setting
- 3 **TEST TONE** Setting
- 4 **DELAY** Setting
- 5 **Input source**

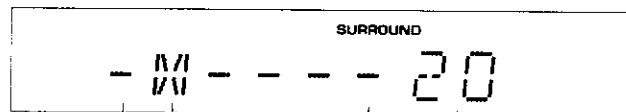

Adjustment position
Front speaker side Surround speaker side Delay time

•The delay time can be adjusted to 15, 20, 25, 30, 40 or 50 ms. Select a value which is closest to the delay value obtained with "How to calculate the proper delay time".

The Sound Retrieval System is an epochal system which produces a three-dimensional sound space by applying the most suitable processing to the sound signal on the basis of the human listening mechanism. This permits real depth and sound location, considered as difficult to realize with conventional 2-channel stereo (general stereo). A sufficient effect can be obtained for any source (CD, tape, broadcasts, etc.).

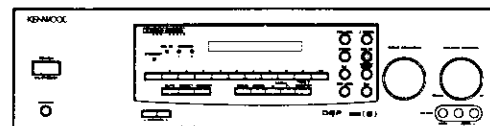
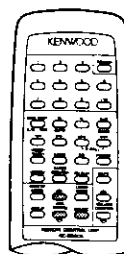

Keys or controls to be used in this operation

SRS 3D Stereo (Sound Retrieval System)

Adjusting the tone.

① Ensure that the S.DIRECT indicator is not lit.

② Turn the SRS 3D stereo ON.



③ Adjust the effect strength (level).

(1) "CENTER" or "SPACE" should be displayed.

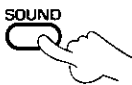

Increasing the "CENTER" level enhances the feeling of depth around the center.

Increasing the "SPACE" level makes the sound expansion wider.

(2) Adjust the level.

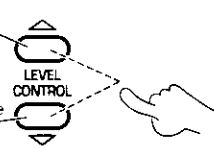

To increase the level

To decrease the level



Each press of the key switches the modes as follows:

- ① SRS 3D is lit
- ② SRS 3D STEREO ON
- ③ SRS 3D is not lit
- ④ SRS 3D STEREO OFF

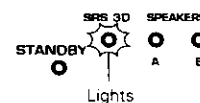

Each press of the key switches the modes as follows:

- ① **CENTER** : Mode for adjusting the depth of SRS 3D.
- ② **SPACE** : Mode for adjusting the expansion of SRS 3D.
- ③ End of setting

- The BASS, MIDDLE and TREBLE adjustments are not available while the SRS 3D Stereo is ON. For the BASS, MIDDLE and TREBLE adjustment procedures.

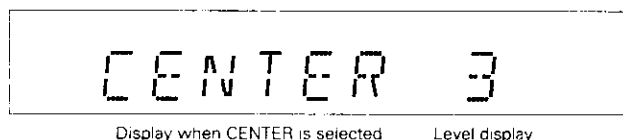

Display when CENTER is selected Level display

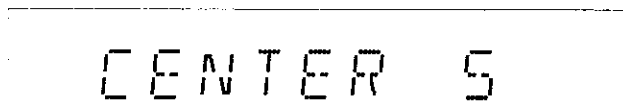

The level value varies

- Adjustment is possible in the range from 1-7.
- Please set as desired according to the titles being played back etc.

Even if the sound is recorded while the SRS 3D stereo effect is applied, the effect is not recorded together with the source sound.

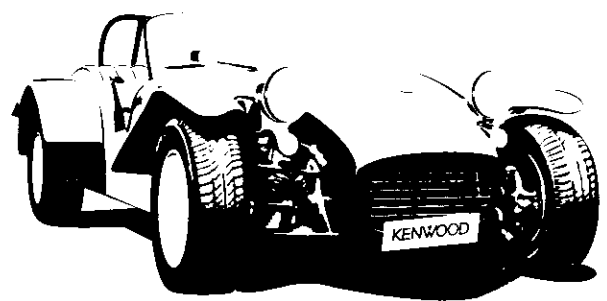

In case of difficulty

KR-300HT (En/K)

What appears to be a malfunction may not always be serious. If your unit should not perform as expected, consult the table below to see if the problem can be corrected before seeking help from your dealer or service representative.

Operation to reset

The microcomputer may fall into malfunction (impossibility to operate, erroneous display, etc.) when the power cord is unplugged while power is ON or due to an external factor. In this case, execute the following procedure to reset the microcomputer and return it to normal condition.

- ① Unplug the AC power plug from the wall outlet.
- ② While holding the POWER switch depressed, plug the AC plug into the power outlet.

● Please note that resetting the microcomputer clears the contents stored in and returns to the condition when it left the factory.



Amplifier

Symptom	Cause	Remedy
Sound is not output or the volume level is low.	<ul style="list-style-type: none"> ● The speaker cords are disconnected. ● MUTE is ON. (The MUTE ON indicator is blinking) ● The SPEAKERS keys are set to OFF. ● The TAPE 2 MONITOR key is set to ON. 	<ul style="list-style-type: none"> ● Connect them properly referring to "Connection of speakers". - 6 ● Press the MUTE key to OFF. - 16 ● Set the SPEAKERS key to ON. - 12 ● Set the TAPE 2 MONITOR key to OFF. Set the input selector to the position other than tuner.
The STANDBY indicator blinks and sound is not output.	<ul style="list-style-type: none"> ● Speaker cords are short-circuited. 	<ul style="list-style-type: none"> ● Turn the power off, eliminate the short-circuiting, then turn on the power again. - 6
Sound is not output from one of the speakers.	<ul style="list-style-type: none"> ● The speaker cord is disconnected. ● The BALANCE control is set to an extreme position. 	<ul style="list-style-type: none"> ● Connect it properly referring to "Connection of speakers". - 6 ● Adjust the Left/Right balance. - 13
Sound is not output from the surround speaker and/or center speaker, or their sound is very small.	<ul style="list-style-type: none"> ● The surround speaker cords and/or center speaker cord are disconnected. ● The Surround play mode has not been engaged. ● The surround and center speaker levels are set to the minimum positions. 	<ul style="list-style-type: none"> ● Connect them properly referring to "Connection of speakers". - 6 ● Set the presence mode. - 22 ● Adjust the surround and center speaker levels.
A hum noise is generated when the PHONO input is selected.	<ul style="list-style-type: none"> ● The audio cord from the turntable is not inserted securely into the PHONO jacks. ● The turntable is not grounded 	<ul style="list-style-type: none"> ● Insert the audio cord plugs securely into the PHONO jacks. - 4 ● Connect the grounding wire to the GND terminal on the rear panel.
System control is not available when TAPE 1 or MD is selected.	<ul style="list-style-type: none"> ● "TAPE 1" or "MD" is not displayed. 	<ul style="list-style-type: none"> ● Switch the display to TAPE 1 or MD. - 12 - 16
System control is not available.	<ul style="list-style-type: none"> ● The XS8 and SL16 modes were switched while the AC plug is left plugged into the wall power outlet 	<ul style="list-style-type: none"> ● Unplug the AC plug from the wall outlet and switch the XS8 or SL16 mode as required. - 5
Display is dimly lit.	<ul style="list-style-type: none"> ● The setting is not correct. 	<ul style="list-style-type: none"> ● Adjust the brightness with the DISPLAY key. - 9

Tuner

Symptom	Cause	Remedy
Radio stations cannot be received.	<ul style="list-style-type: none"> ● No antenna is connected. ● The broadcast band is not set properly ● The frequency of the desired station is not tuned. 	<ul style="list-style-type: none"> ● Connect an antenna. - 7 ● Set the broadcast band properly. - 17 ● Tune the frequency of the desired station. - 17
Interference.	<ul style="list-style-type: none"> ● Noise due to ignition noise of an automobile. ● Noise due to an influence from an electric appliance. ● Noise due to a nearby TV set. 	<ul style="list-style-type: none"> ● Install the outdoor antenna away from the road. ● Turn off the power to the appliance. ● Install the system farther away from the TV set.
A station which was preset cannot be received by pressing the corresponding numeric key.	<ul style="list-style-type: none"> ● The preset station belongs to a frequency that cannot be received. ● The preset memory was cleared because the power cord had been unplugged for a long period of time. ● The TUNER input is not detected. 	<ul style="list-style-type: none"> ● Preset a station with a receivable frequency. - 19 ● Preset the station again. - 19 ● Select the TUNER input

Remote control unit

Symptom	Cause	Remedy
Remote control operation is not possible.	<ul style="list-style-type: none"> ● Batteries are exhausted. ● The remote control unit is too far away from the main system, controlling angle is too large, or there is an obstacle in between. ● The audio cords and system control cords are not connected properly. ● The source component to be operated does not contain the tape(s) or CD. ● An attempt is made to play a tape which is being recorded in the cassette deck. 	<ul style="list-style-type: none"> ● Replace with new batteries.  - 10 ● Operate the remote control unit within the controllable range.  - 11 ● Connect properly referring to "System connection".  - 24 ● Place the tape(s) or CD in the source component to be played. ● Wait until the recording is completed.

Memory backup function

Please note that the following items will be deleted from this unit's memory if the power cord is disconnected from the AC outlet or the main power switch is turned off for approximately three days.

- The power setting is cleared and the power is set to OFF.
- The input selection is cleared and the TUNER input is selected.
- The volume setting is cleared and the volume is set to -80 dB.
- The receiving band setting is cleared and the FM band is selected.
- The frequency setting is cleared and 87.5 MHz is selected.
- The preset station memory is cleared.



Do not use contact cleaners because it could cause a malfunction. Be specially careful against contact cleaners containing oil, for they may deform the plastic components.

For the U.S.A.**FCC WARNING**

This equipment may generate or use radio frequency energy. Changes or modifications to this equipment may cause harmful interference unless the modifications are expressly approved in the instruction manual. The user could lose the authority to operate this equipment if an unauthorized change or modification is made.

NOTE:

This equipment has been tested and found to comply with the limits for a Class B digital device, pursuant to Part 15 of the FCC Rules. These limits are designed to provide reasonable protection against harmful interference in a residential installation. This equipment may cause harmful interference to radio communications, if it is not installed and used in accordance with the instructions. However, there is no guarantee that interference will not occur in a particular installation. If this equipment does cause harmful interference to radio or television reception, which can be determined by turning the equipment off and on, the user is encouraged to try to correct the interference by one or more of the following measures:

- Reorient or relocate the receiving antenna.
- Increase the separation between the equipment and receiver.
- Connect the equipment into an outlet on a circuit different from that to which the receiver is connected.
- Consult the dealer or an experienced radio / TV technician for help.

For the U.S.A.**Note to CATV system installer:**

This reminder is provided to call the CATV system installer's attention to Article 820-40 of the NEC that provides guidelines for proper grounding and, in particular, specifies that the cable ground shall be connected to the grounding system of the building, as close to the point of cable entry as practical.

Specifications U.S.A. and Canada

KR-300HT (En/K)

⚠ Caution : Read this page carefully to ensure safe operation.

Audio section

Rated power output at the STEREO operation

120 watts per channel minimum RMS, both channels driven at 8 Ω, from 40 Hz to 20,000 Hz with no more than 0.8 % total harmonic distortion. (FTC)

Power output at the SURROUND operation

Front

120 watts per channel minimum RMS, both channels driven, at 8 Ω, 1 kHz with no more than 0.8 % total harmonic distortion.

Center

120 watts minimum RMS at 8 Ω, 1 kHz with no more than 0.8% total harmonic distortion.

Surround

120 watts per channel minimum RMS, at 8 Ω, 1 kHz with no more than 0.8 % total harmonic distortion.

Total harmonic distortion 0.3 % (1 kHz, 60 W, 8 Ω)

Signal to noise ratio (IHF'66)

PHONO (MM) 75 dB

LINE (CD) 93 dB

Input sensitivity / impedance

PHONO (MM) 3.0 mV / 47 kΩ

CD 220 mV / 47 kΩ

Tone controls

BASS ± 8 dB (at 100 Hz)

MIDDLE ± 8 dB (at 900 Hz)

TREBLE ± 8 dB (at 10 kHz)

N.B. circuit + 5 dB (80 Hz)

Output level / impedance

Sub woofer preout 1.0 V / 2.2 kΩ

Video section

VIDEO inputs / outputs (Composite) 1 Vp-p / 75 Ω

FM Tuner section

Tuning frequency range 87.5 MHz ~ 108 MHz

Usable sensitivity

MONO 1.3 μV (at 75 Ω) / 13.2 dBf
(75 kHz dev., SINAD 30 dB)

50 dB quieting sensitivity

STEREO 31.6 μV (at 75 Ω) / 41.2dBf

Total harmonic distortion (1 kHz)

MONO 0.5 % (65 dBf input)

STEREO 0.6 % (65 dBf input)

Signal to noise ratio (1 kHz 75 kHz dev.)

MONO 75 dB (65 dBf input)

STEREO 68 dB (65 dBf input)

Stereo separation (1 kHz) 40 dB

Selectivity (IHF ±400 kHz) 66 dB

Frequency response 30 Hz ~15 kHz, + 0.5 dB, - 3.0 dB

AM Tuner section

Tuning frequency range 530 kHz ~ 1,700 kHz

Usable sensitivity (30 % mod., S/N 20 dB)

..... 15 μV / (500 μV / m)

Signal to noise ratio (30 % mod., 1 mV input) 48 dB

General

Power consumption 2.8 A

⚠ AC outlet

SWITCHED 1: (50 W, 0.42 A max.)

Dimensions W:440 mm (17-5/16")

H:127 mm (5")

D:389 mm (15-5/16")

Weight (net) 9.0 kg (19.9 lb)



1 KENWOOD follows a policy of continuous advancements in development. For this reason specifications may be changed without notice.
2. Full performance may not be exhibited in extremely cold locations (below 0 deg.C).

Specifications Other countries

KR-300HT (E/K)

31

⚠ **Caution** : Read this page carefully to ensure safe operation.

Audio section

Rated power output at the STEREO operation

110 watts per channel minimum RMS, both channels driven at 8 Ω, from 40 Hz to 20,000 Hz with no more than 0.7 % total harmonic distortion. (FTC)

1 kHz, 10 % THD at 8 Ω 130 W + 130 W
(DIN/IEC) from 63 Hz to 12,500 Hz,
0.7 % T.H.D., at 8 Ω 110 W + 110 W

Power output at the Surround operation

Front (1 kHz, 0.7 % T.H.D. at 8 Ω) 110 W + 110 W
Center (1 kHz, 0.7 % T.H.D. at 8 Ω) 110 W
Surround (1 kHz, 0.7 % T.H.D. at 8 Ω) 110 W

Front (1 kHz, 10 % T.H.D. at 8 Ω) 130 W + 130 W
Center (1 kHz, 10 % T.H.D. at 8 Ω) 130 W
Surround (1 kHz, 10 % T.H.D. at 8 Ω) 130 W

Total harmonic distortion (1 kHz, 8 Ω) 0.3 % at 55 W

Signal to noise ratio (IHF'66)

PHONO (MM) 75 dB
CD 93 dB

Input sensitivity / impedance

PHONO (MM) 3.0 mV / 47 kΩ
CD 220 mV / 47 kΩ

Output level / impedance

Sub woofer preout 1.0 V / 2.2 kΩ

Tone controls

BASS ± 8 dB (at 100 Hz)
MIDDLE ± 8 dB (at 900 Hz)
TREBLE ± 8 dB (at 10 kHz)

N.B. circuit + 5 dB (80 Hz)

Video section

VIDEO inputs / outputs (Composite) 1 Vp-p / 75 Ω

FM Tuner section

Tuning frequency range 87.5 MHz~108 MHz

Usable sensitivity

MONO 2.0 μV (at 75 Ω) / 17.2 dBf
(75 kHz dev., S/N 30 dB)

50 dB quieting sensitivity

STEREO 35 μV (at 75 Ω) / 42.2 dBf

Total harmonic distortion (1 kHz)

MONO 0.7 % (65 dBf input)

STEREO 0.8 % (65 dBf input)

Signal to noise ratio (1 kHz 75 kHz dev.)

MONO 73 dB (65 dBf input)

STEREO 66 dB (65 dBf input)

Selectivity (IHF ± 400 kHz) 50 dB

Stereo separation (1 kHz) 40 dB

Frequency response 30 Hz ~ 15 kHz, + 0.5 dB, - 3.0 dB

AM Tuner section

Tuning frequency range

9 kHz 531 kHz ~ 1,602 kHz

10 kHz 530 kHz ~ 1,610 kHz

Usable sensitivity (30 % mod., S/N 20 dB)

..... 13 μV / (500 μV / m)

Signal to noise ratio (30 % mod., 1 mV input) 50 dB

General

Power consumption 250 W

⚠ AC outlet

SWITCHED 1: (50 W max.)

Dimensions W: 440 mm

H: 127 mm

D: 389 mm

Weight (net) 9.0 kg



1. KENWOOD follows a policy of continuous advancements in development. For this reason specifications may be changed without notice.
2. Full performance may not be exhibited in extremely cold locations (below 0 deg. C).

KENWOOD

For your records

Record the serial number, found on the back of the unit, in the spaces designated on the warranty card, and in the space provided below. Refer to the model and serial numbers whenever you call upon your dealer for information or service on this product.

Model _____ Serial Number _____